

JTAG CONNECTIONS AND PINOUTS

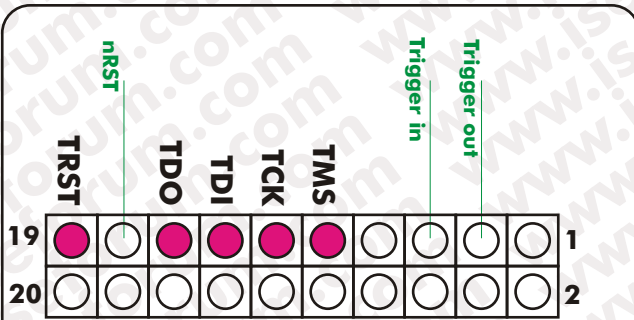

20 pin standard pinout

درگاه استاندارد ۲۰ پایه در رسیورهای جدید

samsung - next - supermax - fortex star
kaon - lazer - sunny - metabox - vision
starsat - daewoo - citizen - rex - strong
techstar - mediacom - etc.

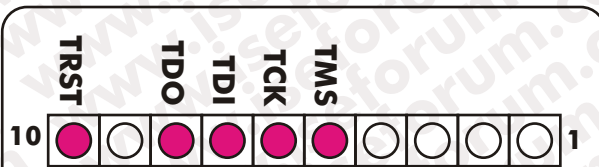
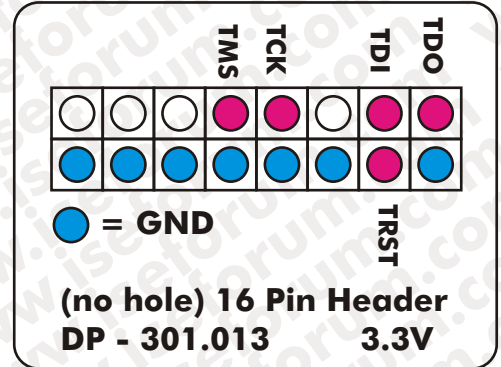
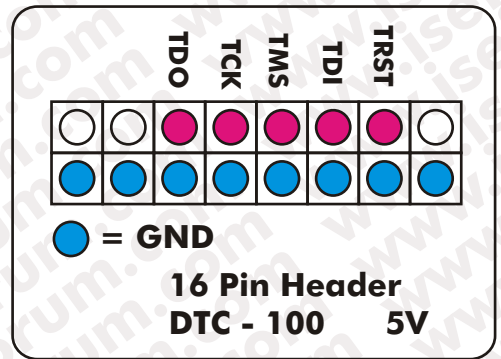

10 pin standard pinout

درگاه استاندارد ۱۰ پایه در رسیورهای جدید

Supermax 9950 ST
Supermax 9950 plus
..... etc.

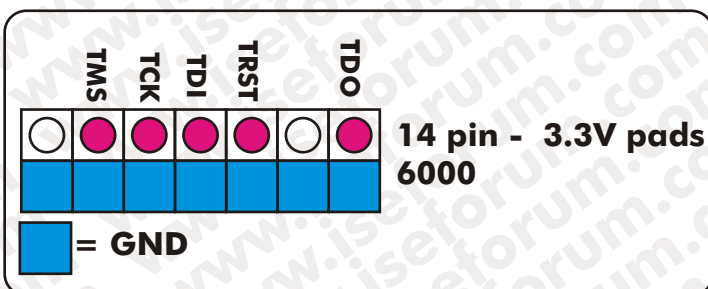
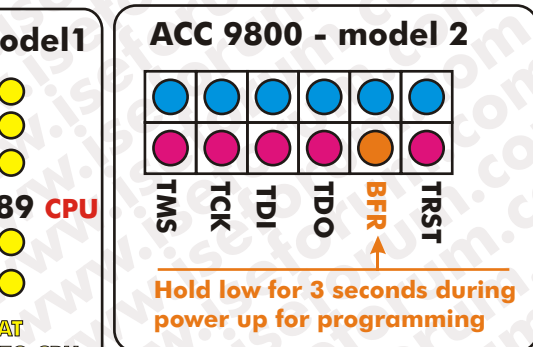
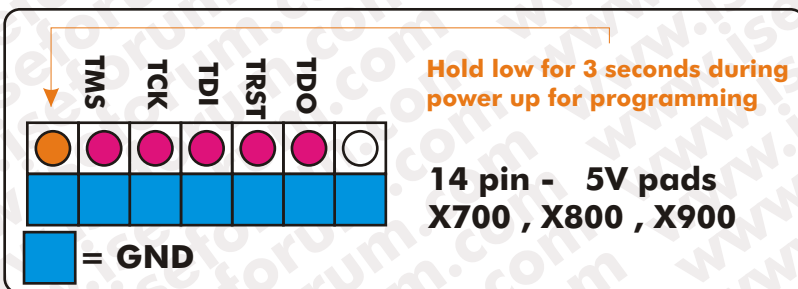
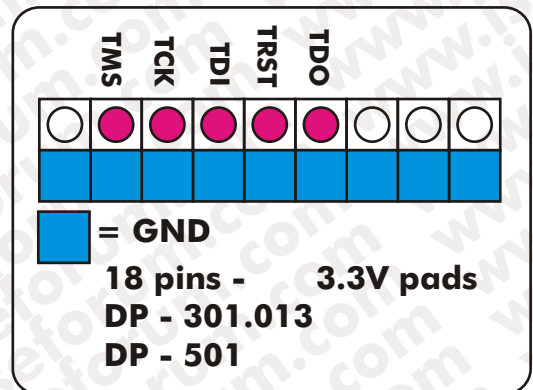
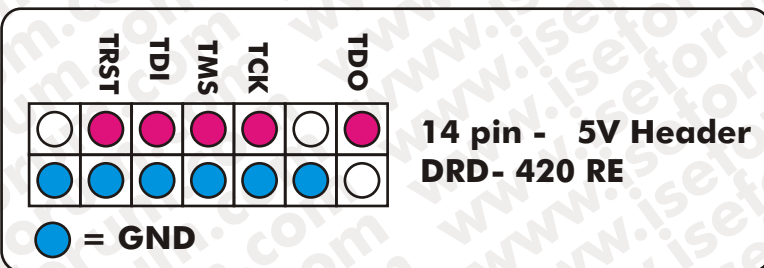
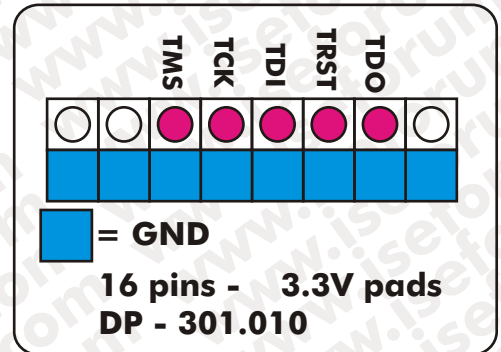
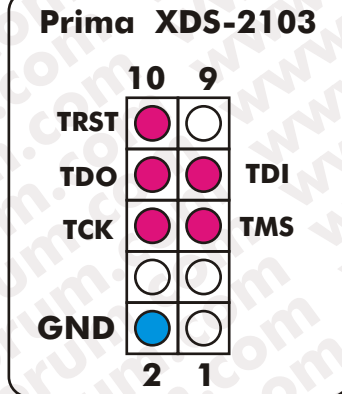

ACC9800 model1

- TMS= R47 ●
- TCK= R49 ●
- TDI= R50 ●
- TDO= Pin189 CPU ●
- TRST= R20 ●
- BFR= R90 ●

● HOT SIDE THAT CONNECTED TO CPU

"COP" pinout for Motorola PowerPC 6xx, 7xx, 8xxx and IBM PowerPC 6xx and 7xx. IBM also refers to this connection as RISCWatch.

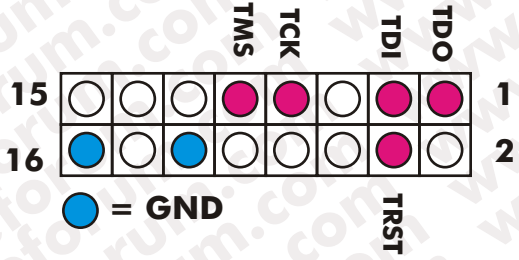

پورت جي تگ در رسيورهای با پردازنده پاور پی سی استفاده شده در برخی رسيور ها از قبيل يو ما تو و غيره

ARM 14pin

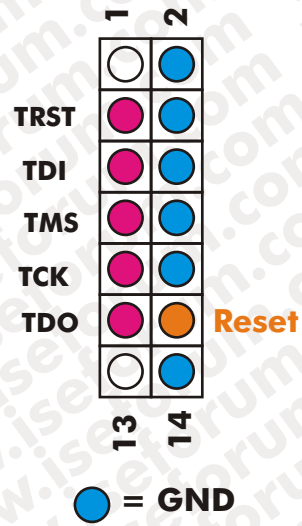

ARM 20pin

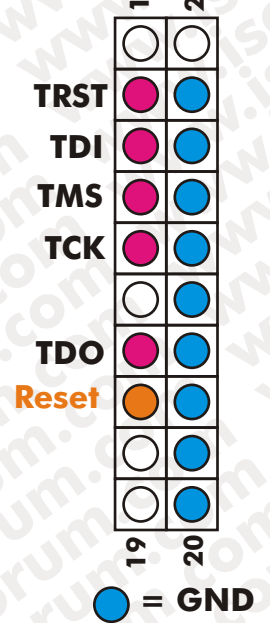

Phillips' MIPS header

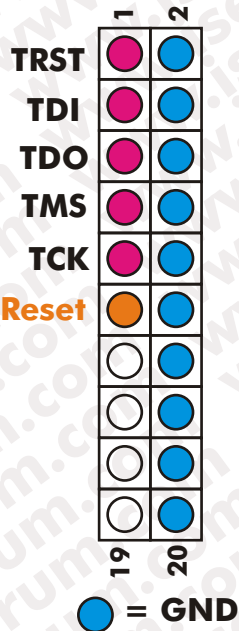

MIPS - EJTAG 2.5

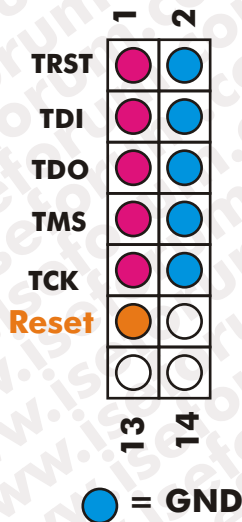

Toshiba's MIPS header

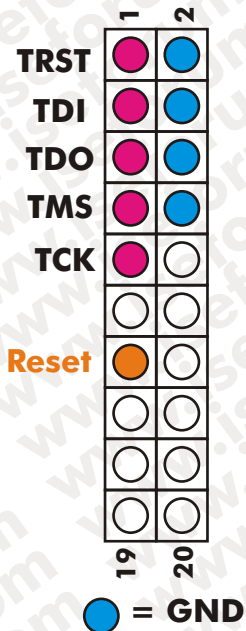

ضمیمه ۱

مدار کامل جي تگ بافر دار

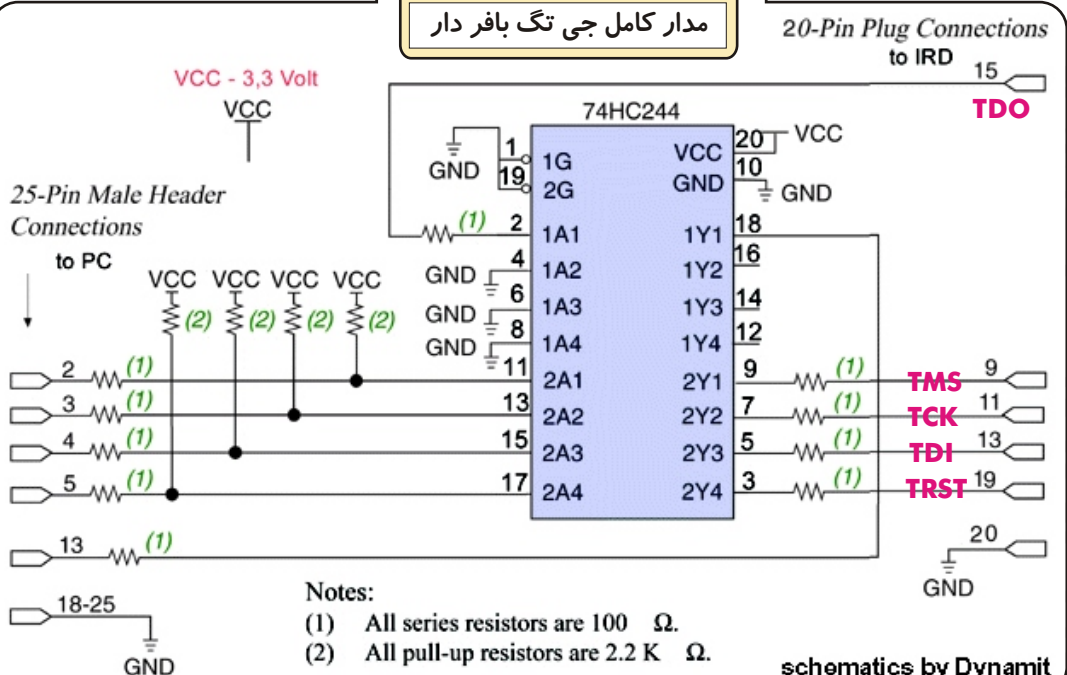

Notes:
 (1) All series resistors are 100 Ω.
 (2) All pull-up resistors are 2.2 K Ω.

schematics by Dynamit